

## ALUMINIUM DIE CAST ENCLOSURES

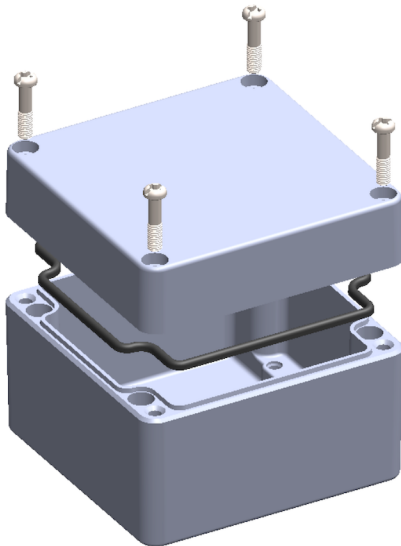

### STANDARD ENCLOSURE KIT

Consists : Lid + Base + Gasket +  
Mounting Screws + Earth Screws



MANUFACTURED BY :



DETAILS	SPECIFICATIONS
<b>DIMENSIONS:</b>	Length (mm) : 120 Width (mm) : 122 Height (mm) : 91
<b>WEIGHT:</b>	979.00 Grams
<b>MATERIAL:</b>	Corrosion Resistant Aluminium Alloy EN AC - AISI12(Fe) DIN 1706
<b>COLOUR OPTIONS:</b>	Natural Finish Powder Coated Silver Grey RAL 7001 Powder Coated Black RAL 9005 Special Colours available upon request.
<b>PROTECTION CLASS:</b>	IP66, IP67 & IP68
<b>PROTECTION AS PER NORM:</b>	IS/EN 60529:2001 - DIN EN60529
<b>GASKET OPTIONS:</b>	Neoprene ( Chloroprene ) : - 40°C to +130°C Silicon : - 60°C to + 200°C EMI/RFI resistant shielded gaskets on special request.
<b>GASKET TYPE:</b>	One piece compression moulded.
<b>IMPACT RESISTANCE:</b>	Upto 7 Joules, without impairment of Ingress Protection
<b>IMPACT RESISTANCE NORM:</b>	IS/IEC 60079-0:2007 EN 60079
<b>LID MOUNTING SCREWS:</b>	Stainless Steel - SS304 / A2
<b>MOUNTING SCREW SIZE:</b>	M6 X 35, Half Thread
<b>SCREW TIGHTENING TORQUE:</b>	Maximum : 5.2 Nm
<b>SCREW HEAD OPTIONS:</b>	Pan Combi, Cheese, Torx, Allen. Any other types upon special request
<b>EARTH SCREWS:</b>	Copper Coated Steel with integral spring washer
<b>MARKING:</b>	CE - conformité européenne.
<b>ENVIRONMENTAL COMPLIANCE:</b>	ROHS - as per Commission Regulation (EU) No.65/2011 REACH - as per Candidate List Promulgated by ECHA Article 57 of EC 1907/2006
<b>CUSTOMIZATION:</b>	Can be machined to customer requirements. Can be made in special colours.

