

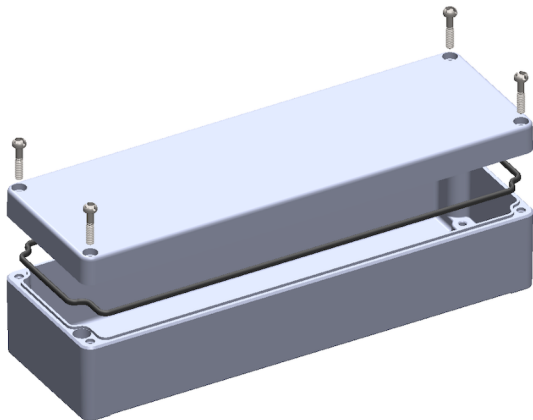

ALUMINIUM DIE CAST ENCLOSURES

DETAILS	SPECIFICATIONS
DIMENSIONS:	Length (mm) : 250 Width (mm) : 80 Height (mm) : 57
WEIGHT:	713.50 Grams
MATERIAL:	Corrosion Resistant Aluminium Alloy EN AC- AISi12(Fe) DIN 1706
COLOUR OPTIONS:	Natural Finish Powder Coated Silver Grey RAL 7001 Powder Coated Black RAL 9005 Special Colours available upon request.
PROTECTION CLASS:	IP66, IP67 & IP68
PROTECTION AS PER NORM:	IS/EN 60529:2001 - DIN EN60529
GASKET OPTIONS:	Neoprene (Chloroprene) : - 40°C to +130°C Silicon : - 60°C to + 200°C EMI/RFI resistant shielded gaskets on special request.
GASKET TYPE:	One piece compression moulded.
IMPACT RESISTANCE:	Upto 7 Joules, without impairment of Ingress Protection
IMPACT RESISTANCE NORM:	IS/IEC 60079-0:2007 EN 60079
LID MOUNTING SCREWS:	Stainless Steel - SS304 / A2
MOUNTING SCREW SIZE:	M4 X 20, Half Thread
SCREW TIGHTENING TORQUE:	Maximum : 1.5 Nm
SCREW HEAD OPTIONS:	Pan Combi, Cheese, Torx, Allen. Any other types upon special request
EARTH SCREWS:	Copper Coated Steel with integral spring washer
MARKING:	CE - conformité européenne.
ENVIRONMENTAL COMPLIANCE:	ROHS - as per Commission Regulation (EU) No.65/2011 REACH - as per Candidate List Promulgated by ECHA Article 57 of EC 1907/2006
CUSTOMIZATION:	Can be machined to customer requirements. Can be made in special colours.



STANDARD ENCLOSURE KIT

Consists : Lid + Base + Gasket + Mounting Screws + Earth Screws



MANUFACTURED BY :

